

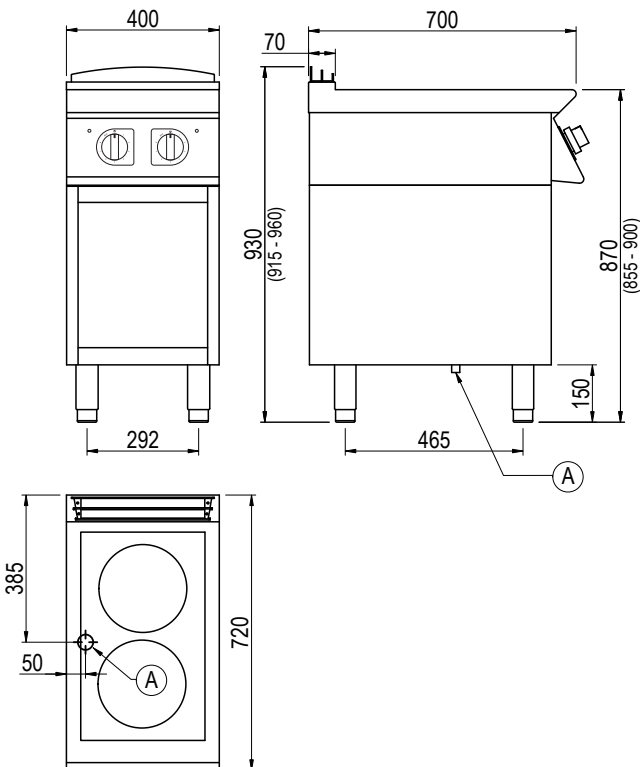

Product Information:

- Class leading, European style, professional quality and reliability since 1963
- 700 series, 6mm, ceramic glass induction boiling top, with two independent cooking zones (2 x 3.8kW)
- Automatic heat generation when induction specific pan is placed on the cooktop
- Automatic shut off when pan is removed from the cooktop
- Precise heat transfer for shorter cook times and enhanced operator safety and comfort
- Independent temperature regulation via 6 position selectors
- LED lights to monitor the correct operation of the appliance
- Robust 304 grade stainless steel construction with rounded corners for improved cleaning
- Open base with optional door available (SPGI.2016437)
- Height adjustable stainless steel feet for a 900mm working height
- 24-month warranty

General Drawing:



Specifications:

Model	CI720GT
W x D x H (mm)	400 x 720 x 930
Weight	55kg
Cooking Zone	2 x Ø230mm
Packed Dimensions (mm)	450 x 825 x 1200
Packed Weight (mm)	60kg
Electrical Connection	3Ø + N + E 415VAC / 50Hz / 7.6kW

Legend:

A Electrical Connection

Due to continuous product research and development, the information contained herein is subject to change without notice.

Revision: 02 - 24/09/2025 - A

www.stoddart.com.au

www.stoddart.co.nz

